

















| COMPOSANTS  | Qty  |
|---|------|
| A          | 1PC  |
| B          | 1PC  |
| C          | 1PC  |
| D          | 5PCS |
| E          | 1PC  |
| F          | 1PC  |
| G          | 1PC  |
| J  M6*35mm | 4PCS |
| P  M6*40mm | 6PCS |
| K  M8*20mm | 3PCS |
| M  M8*ø17  | 7PCS |
| N  M6*ø14  | 6PCS |
| H          | 1PC  |
| L          | 1PC  |
| Q  M6*25mm | 2PCS |
| O  M6      | 1PC  |

1



2

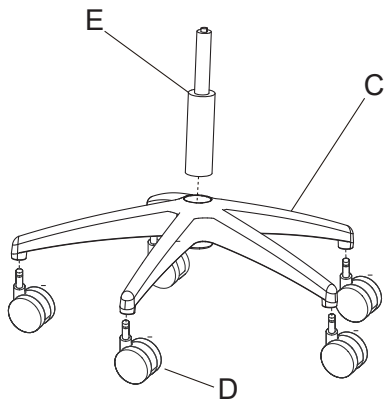
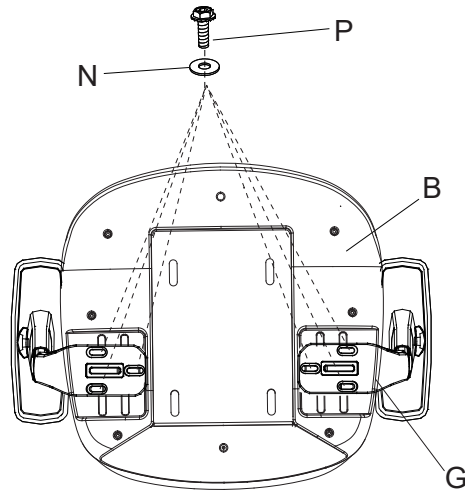

3

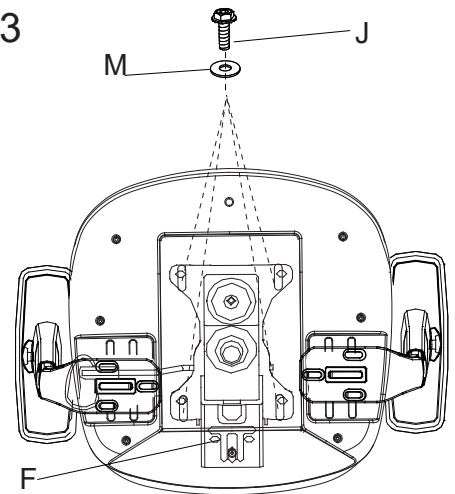

4

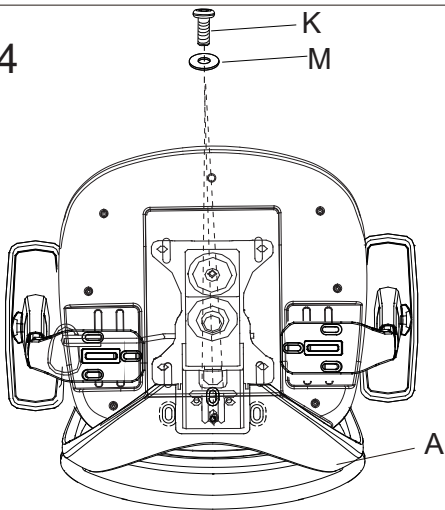

5

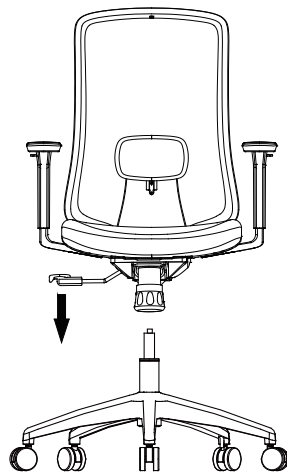

6

