

05/02/19

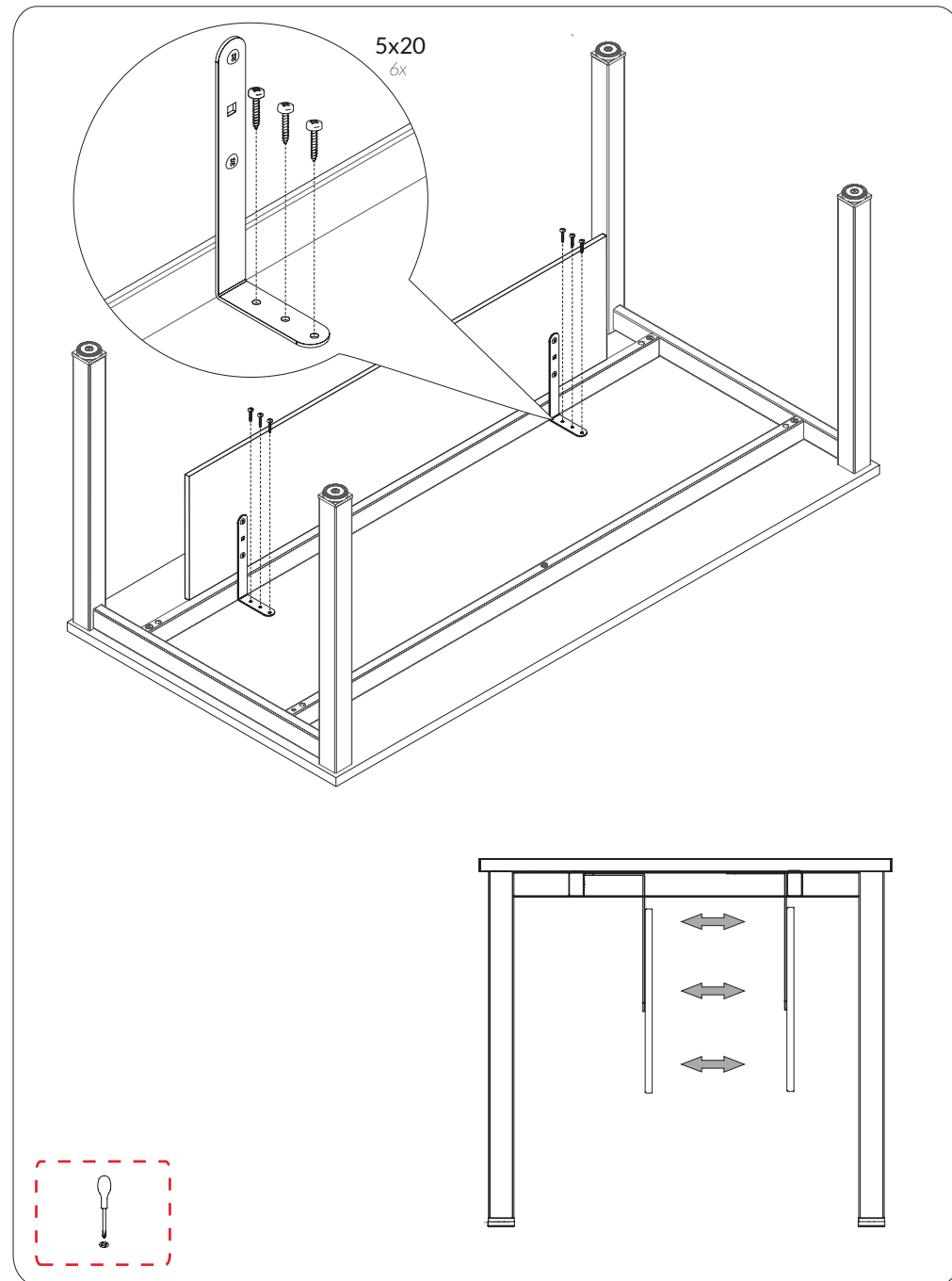

05/02/19